

rollyAir Tyres

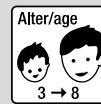

rolly toys Kundendienst Deutschland:

Tel: +49 (0) 95 68 / 856-142
 Fax: +49 (0) 95 68 / 856-183
 e-mail: service@rollytoys.de



2026/01

918.000.800.00

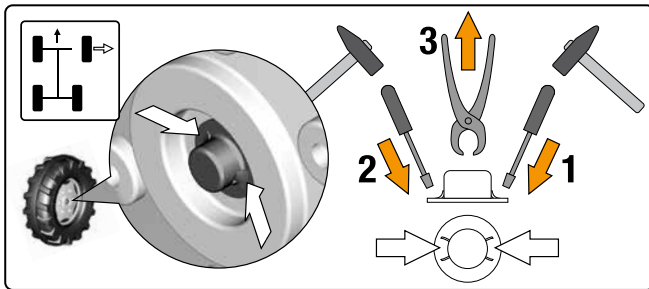

A1

(BG) Предупреждение!	(LT) Įspėjimas!
(CZ) Varování!	(LV) Uzmanību!
(D) Achtung!	(M) Atvairi!
(DK) Advarsel!	(MK) Вниманије!
(E) Aviso!	(N) OBS!
(EST) Hoiatust!	(NL) Waarschuwing!
(F) Attention!	(P) Aviso!
(FIN) Varoitus!	(PL) Ostrożnie!
(GB) Warning!	(RO) Avertisment!
(GR) Προσοχή!	(RUS) Внимание!
(H) Figyelmeztetés!	(S) Varning!
(HR) Pažnja!	(SK) Varovanie!
(I) Avviso!	(SLD) Opozorilo!
(JL) Rabhchán!	(TR) Dikkat!

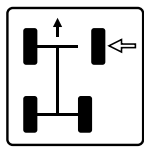
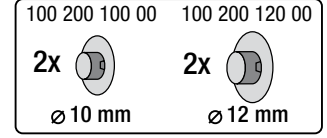
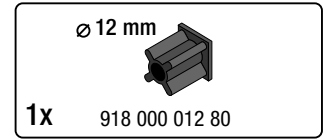
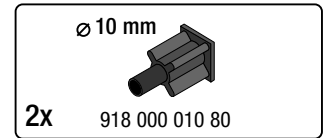

- 918 002 000 12
- 918 002 000 20
- 918 002 000 70
- 918 002 000 75

- 918 003 000 12
- 918 003 000 20
- 918 003 000 70
- 918 003 000 75

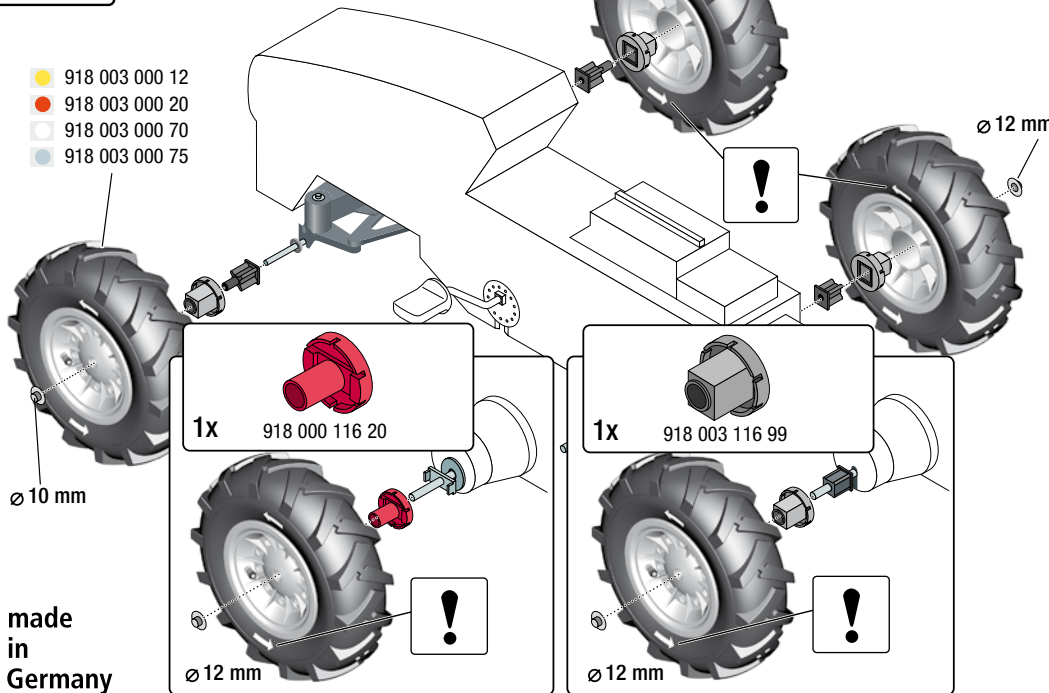

made in Germany



AVERTISSEMENT

- RISQUE D'ÉTOUFFEMENT - Petites pièces. Risque d'ingestion. Contient des petites pièces à l'état non assemblé. Doit être assemblé par un adulte.
- Surveillance d'un adulte est requise
- Ne jamais utiliser à proximité des marches, des pentes, des allées, des collines, des routes, des allées ou des piscines.
- Portez toujours des chaussures.
- Ne permettez jamais la présence de plus d'un coureur.
- L'utilisation d'un équipement de protection et d'un casque de sécurité est fortement recommandée.
- Conforme aux exigences de la norme internationale ASTM Standard Consumer Safety Specification on Toy Safety, F 963.
- Ne convient pas aux enfants de moins de 3 ans.

WARNING

- CHOKING HAZARD: Small parts. Danger of being swallowed. Contains small parts in non assembled state. Must be assembled by adults.
- Adult supervision required.
- Never use near steps, slopes, driveways, hills, roadways, alleys or swimming pool areas.
- Always wear shoes.
- Never allow more than one rider.
- The use of protective gear and a safety helmet is highly recommended.
- Conforms to the requirements of ASTM Standard Consumer Safety Specification on Toy Safety, F 963
- Not suitable for children under 3 years.

---NORTH & SOUTH AMERICA only---

180 days warranty

From the date of purchase + guaranteed spare part service
 The warranty does not cover damages caused by improper use or neglect



Franz Schneider GmbH & Co KG
 Siemensstrasse 13-19
 D-96465 · Neustadt bei Coburg · Germany
 Tel.: +49 (0) 95 68 / 856-0
 Fax.: +49 (0) 95 68 / 856-190
 www.rollytoys.de

